

# Inductors for Power Supply Circuit

Wound/STD • magnetic shielded

## VLM series

Type:           VLM10555-2  
                  VLM10555-3  
                  VLM13580-D1

Issue date:     September 2011

- All specifications are subject to change without notice.
  - Conformity to RoHS Directive: This means that, in conformity with EU Directive 2002/95/EC, lead, cadmium, mercury, hexavalent chromium, and specific bromine-based flame retardants, PBB and PBDE, have not been used, except for exempted applications.
-

# Inductors for Power Supply Circuit Wound/STD • Magnetic Shielded

Conformity to RoHS Directive

## VLM Series VLM10555-2

### FEATURES

- Low loss and large current capability design.
- High magnetic shield construction should actualize high resolution for EMC protection.
- Magnetic coupling type core with low magnetic flux leakage and a three-terminal structure.
- Available for automatic mounting in tape and reel package.

### APPLICATIONS

Note book type and mobile computers, amusement equipment, DVD players, VRMs, plasma displays, etc.

### SHAPES AND DIMENSIONS

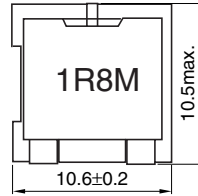

Dimensions in mm



### RECOMMENDED PC BOARD PATTERN

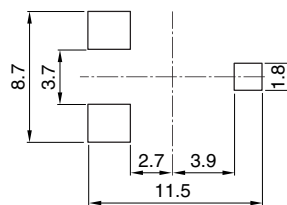

Dimensions in mm

### CIRCUIT DIAGRAM

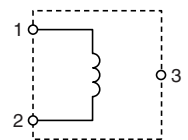

### ELECTRICAL CHARACTERISTICS

Part No.	Inductance (μH)	Inductance tolerance (%)	Test frequency (kHz)	DC resistance (mΩ)		Rated current(A)*		Based on temperature rise typ.
				[±15%]	typ.	Based on inductance change max. (typ.)	Based on inductance change max. (typ.)	
VLM10555T-1R8M8R8-2	1.8	±20	100	5.6	5.6	18(20)	14(16)	8.8
VLM10555T-2R5M8R0-2	2.5	±20	100	6.7	6.7	15(17)	12(14)	8
VLM10555T-3R3M7R2-2	3.3	±20	100	8.3	8.3	12(14)	10(12)	7.2
VLM10555T-4R3M7R2-2	4.3	±20	100	8.3	8.3	9(11)	7(9)	7.2

\* Rated current: Value obtained when current flows and the temperature has risen to 40°C or when DC current flows and the nominal value of inductance has fallen by 30%, whichever is smaller.

- Operating temperature range: -40 to +125°C (Including self-temperature rise)
- Test equipment WK 3260B PRECISION MAGNETICS ANALYZER, WK 3265B 25A DC BIAS UNIT, or equivalent

### TYPICAL ELECTRICAL CHARACTERISTICS

#### INDUCTANCE CHANGE vs. DC SUPERPOSITION CHARACTERISTICS

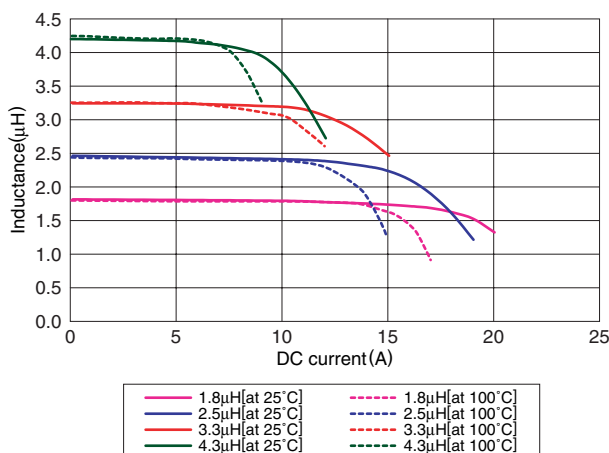

#### TEMPERATURE RISE CHARACTERISTICS

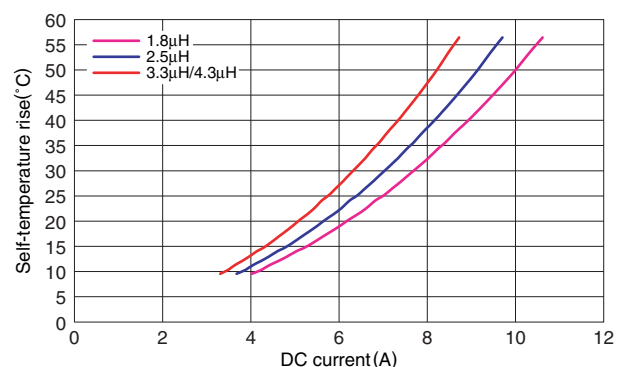

• Conformity to RoHS Directive: This means that, in conformity with EU Directive 2002/95/EC, lead, cadmium, mercury, hexavalent chromium, and specific bromine-based flame retardants, PBB and PBDE, have not been used, except for exempted applications.

• All specifications are subject to change without notice.

# Inductors for Power Supply Circuit

## Wound/STD • Magnetic Shielded

Conformity to RoHS Directive

### VLM Series VLM10555-3

#### FEATURES

- Low loss and large current capability design.
- High magnetic shield construction should actualize high resolution for EMC protection.
- Magnetic coupling type core with low magnetic flux leakage and a three-terminal structure.
- Available for automatic mounting in tape and reel package.

#### APPLICATIONS

Note book type and mobile computers, amusement equipment, DVD players, VRMs, plasma displays, etc.

#### SHAPES AND DIMENSIONS

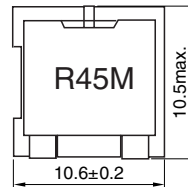

Dimensions in mm



#### RECOMMENDED PC BOARD PATTERN

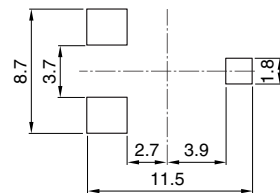

Dimensions in mm

#### CIRCUIT DIAGRAM

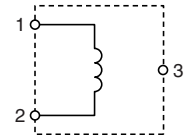

#### ELECTRICAL CHARACTERISTICS

Part No.	Inductance (nH)	Inductance tolerance (%)	Test frequency (kHz)	DC resistance (mΩ)		Rated current(A)*		Based on temperature rise typ.
				max.	typ.	Based on inductance change max.	Based on inductance change max.	
VLM10555T-R33M180-3	330	±20	100	1.2	0.95	34	30	18
VLM10555T-R45M110-3	450	±20	100	2.6	2.2	40	34	11
VLM10555T-R56M120-3	560	±20	100	2.5	2.1	34	26	12
VLM10555T-R70M120-3	700	±20	100	2.5	2.1	26	21	12
VLM10555T-1R2M100-3	1200	±20	100	3.2	2.7	18	15	10

\* Rated current: Value obtained when current flows and the temperature has risen to 40°C or when DC current flows and the nominal value of inductance has fallen by 30%, whichever is smaller.

- Operating temperature range: -40 to +125°C (Including self-temperature rise)
- Test equipment WK 3260B PRECISION MAGNETICS ANALYZER, WK 3265B 25A DC BIAS UNIT, or equivalent

#### TYPICAL ELECTRICAL CHARACTERISTICS

##### INDUCTANCE CHANGE vs. DC SUPERPOSITION CHARACTERISTICS

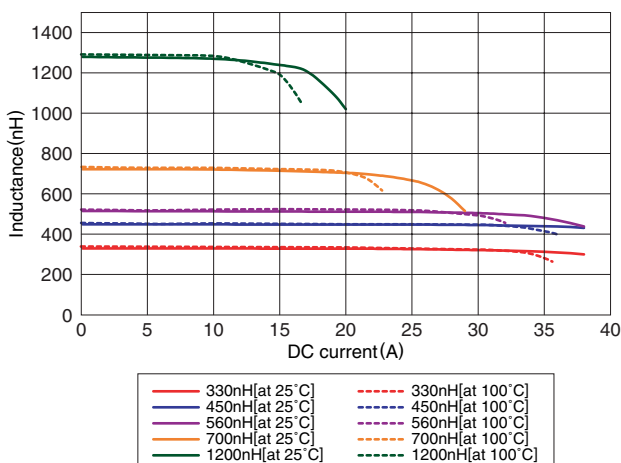

##### TEMPERATURE RISE CHARACTERISTICS

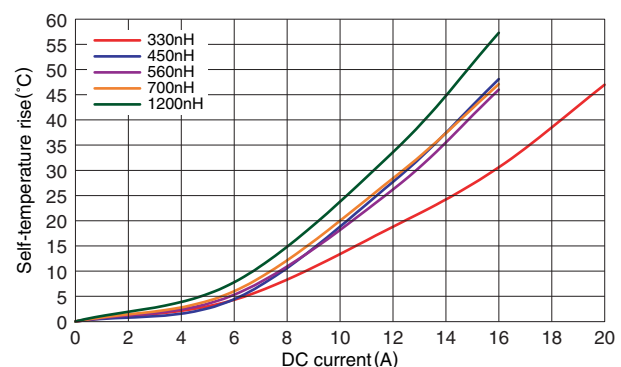

• Conformity to RoHS Directive: This means that, in conformity with EU Directive 2002/95/EC, lead, cadmium, mercury, hexavalent chromium, and specific bromine-based flame retardants, PBB and PBDE, have not been used, except for exempted applications.

• All specifications are subject to change without notice.

# Inductors for Power Supply Circuit Wound/STD • Magnetic Shielded

Conformity to RoHS Directive

## VLM Series VLM13580-D1

### FEATURES

- Low loss and large current capability design.
- High magnetic shield construction should actualize high resolution for EMC protection.
- Magnetic coupling type core with low magnetic flux leakage and a three-terminal structure.
- Available for automatic mounting in tape and reel package.

### APPLICATIONS

Mobile computers etc.

### SHAPES AND DIMENSIONS

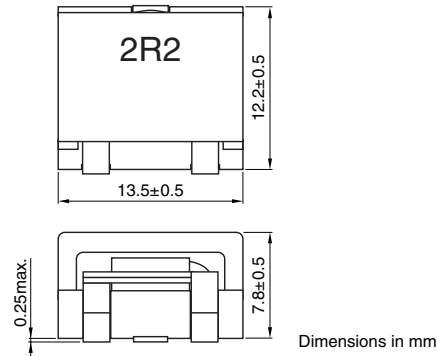

### RECOMMENDED PC BOARD PATTERN

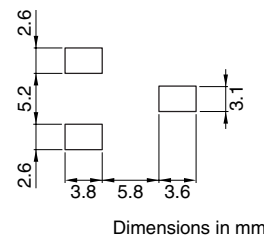

### CIRCUIT DIAGRAM

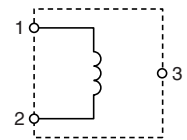

### ELECTRICAL CHARACTERISTICS

Part No.	Inductance (μH)	Inductance tolerance (%)	Test frequency (kHz)	DC resistance (mΩ)		Rated current(A)*		
				[±15%] max.	typ.	Based on inductance change max.	Based on temperature rise typ.	Self-temperature rise 20°C
VLM13580T-R82M-D1	0.82	±20	100	2	1.7	36	12.6	18.5
VLM13580T-1R5M-D1	1.5	±20	100	2.5	2.1	26	11.7	17.2
VLM13580T-2R2M-D1	2.2	±20	100	3.9	3.3	20	10.5	14.8
VLM13580T-3R3M-D1	3.3	±20	100	4.5	3.8	18	8.4	11.7

\* Rated current: Value obtained when current flows and the temperature has risen to 20°C or 40°C or when DC current flows and the initial value of inductance has fallen by 30%, whichever is smaller.

- Operating temperature range: -40 to +150°C (Including self-temperature rise)
- Test equipment WK 3260B PRECISION MAGNETICS ANALYZER, WK 3265B 25A DC BIAS UNIT, or equivalent

### TYPICAL ELECTRICAL CHARACTERISTICS

#### INDUCTANCE CHANGE vs. DC SUPERPOSITION CHARACTERISTICS

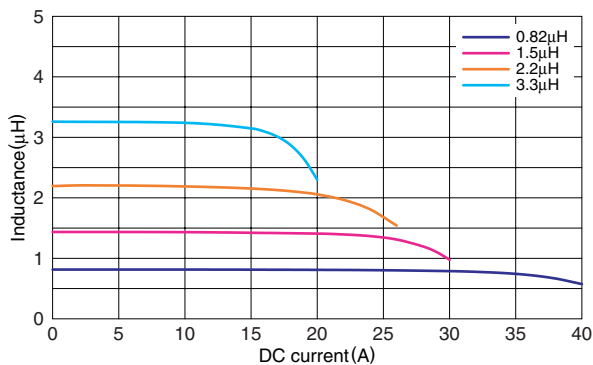

#### TEMPERATURE RISE CHARACTERISTICS

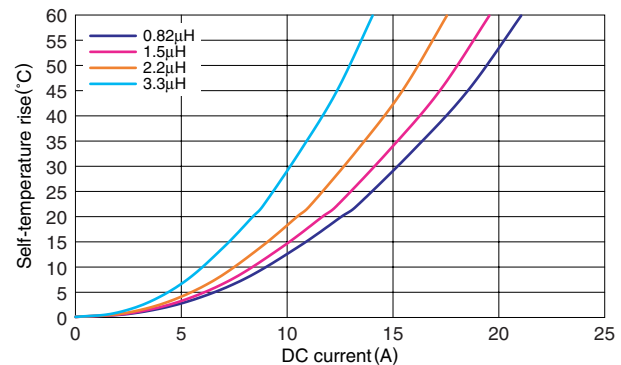

• Conformity to RoHS Directive: This means that, in conformity with EU Directive 2002/95/EC, lead, cadmium, mercury, hexavalent chromium, and specific bromine-based flame retardants, PBB and PBDE, have not been used, except for exempted applications.

• All specifications are subject to change without notice.