

Package: 3mmx3mm QFN



Product Description

The FMS2016-005 is a low loss, high power, linear single-pole four-throw Gallium Arsenide antenna switch designed for use in mobile handset and other high power switching applications. The die is fabricated using the RFMD FLO5 0.5μm switch process technology, which offers excellent performance optimized for switch applications.

Optimum Technology Matching® Applied

- GaAs HBT
- GaAs MESFET
- InGaP HBT
- SiGe BiCMOS
- Si BiCMOS
- SiGe HBT
- GaAs pHEMT
- Si CMOS
- Si BJT
- GaN HEMT
- InP HBT
- RF MEMS
- LDMOS

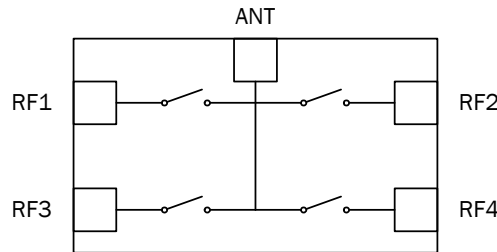

Features

- Excellent Low Control Voltage Performance
- Excellent Harmonic Performance Under GSM/DCS/PCS/EDGE Power Levels
- High Isolation: > 30dB typ. at 1.8GHz
- NiPdAu Finish for Military and High Reliability Applications

Applications

- Multi-band GSM/DCS/PCS/EDGE Hand-set Modules
- High Power and Linear RF Switching Applications

Parameter	Specification			Unit	Condition
	Min.	Typ.	Max.		
Electrical Specifications					$T_{AMBIENT} = 25^{\circ}C$, $V_{CTRL} = 0V/2.7V$, $Z_{IN} = Z_{OUT} = 50\Omega$ External DC-blocking capacitors are required on all RF ports (typ. 47 pF)
Insertion Loss		0.55	0.75	dB	0.5 GHz to 1.0GHz
		0.65	0.85	dB	1.0GHz to 2.0GHz
Return Loss	16	20		dB	0.5GHz to 2.5GHz
Isolation		34		dB	0.5GHz to 1.0GHz
	30	32		dB	1.0GHz to 2.0GHz; RF1 to RF2, RF1 to RF3, RF2 to RF4
Isolation		34		dB	0.5GHz to 1.0GHz
	26	30		dB	1.0GHz to 2.0GHz; RF3 to RF4
2nd Harmonic Level		-75	-60	dBc	1GHz, $P_{IN} = +35$ dBm, 100% duty cycle
		-75	-65	dBc	2GHz, $P_{IN} = +35$ dBm, 100% duty cycle
3rd Harmonic Level		-75	-60	dBc	1GHz, $P_{IN} = +35$ dBm, 100% duty cycle
		-75	-65	dBc	2GHz, $P_{IN} = +35$ dBm, 100% duty cycle
Switching Speed: T_{RISE} , T_{FALL}		<0.3		μs	10% to 90% RF and 90% to 10% RF
Switching Speed: T_{ON} , T_{OFF}			0.5	μs	50% control to 90% RF and 50% control to 10% RF
Control Current		<10	15	μA	+35 dBm RF input at 1GHz
IP3		>68		dBm	0.9GHz and 0.91GHz, $P_{IN} = +20$ dBm
		>66		dBm	1.85GHz and 1.86GHz, $P_{IN} = +20$ dBm
PO.1dB		>38		dBm	1.0GHz
		>37		dBm	2.0GHz

RF MICRO DEVICES®, RFMD®, Optimum Technology Matching®, Enabling Wireless Connectivity™, PowerStar®, POLARIS™ TOTAL RADIO™ and UltimateBlue™ are trademarks of RFMD, LLC. BLUETOOTH is a trademark owned by Bluetooth SIG, Inc., U.S.A. and licensed for use by RFMD. All other trade names, trademarks and registered trademarks are the property of their respective owners. ©2006, RF Micro Devices, Inc.

Absolute Maximum Ratings¹

Parameter	Rating	Unit
Maximum Input Power (P_{IN})	+38	dBm
Control Voltage (V_{CTRL})	+6	V
Operating Temperature (T_{OPER})	-40 to 100	°C
Storage Temperature (T_{STOR})	-55 to 150	°C



Caution! ESD sensitive device.

Exceeding any one or a combination of the Absolute Maximum Rating conditions may cause permanent damage to the device. Extended application of Absolute Maximum Rating conditions to the device may reduce device reliability. Specified typical performance or functional operation of the device under Absolute Maximum Rating conditions is not implied.

RoHS status based on EU Directive 2002/95/EC (at time of this document revision).

The information in this publication is believed to be accurate and reliable. However, no responsibility is assumed by RF Micro Devices, Inc. ("RFMD") for its use, nor for any infringement of patents, or other rights of third parties, resulting from its use. No license is granted by implication or otherwise under any patent or patent rights of RFMD. RFMD reserves the right to change component circuitry, recommended application circuitry and specifications at any time without prior notice.

Truth Table

Path(s)	V1	V2	V3	V4
RF1 to ANT	High	Low	Low	Low
RF2 to ANT	Low	High	Low	Low
RF3 to ANT	Low	Low	High	Low
RF4 to ANT	Low	Low	Low	High

Note: High 2.7V to 6V; Low 0V to 0.2V

Typical Measured Performance on Evaluation Board

Measurement Conditions: $V_{CTRL} = 0V$ (low) and $2.5V$ (high), $T_{AMBIENT} = 25^{\circ}C$ unless otherwise stated.

Insertion Loss

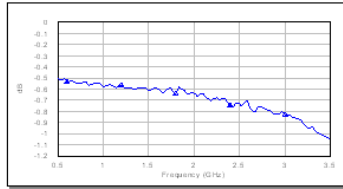

RF1 to RF2 Isolation

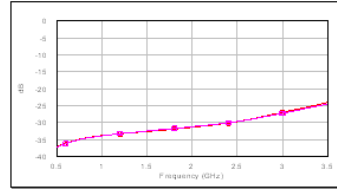

RF3 to RF4 Isolation

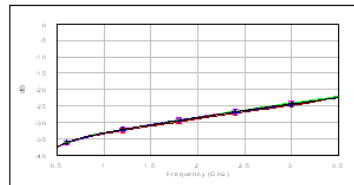

RF1 to RF3 AND RF2 to RF4 Isolation

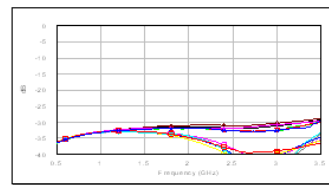

Return Loss

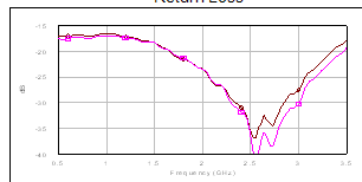

Evaluation Board De-Embedding Data (Measured)

Insertion Loss

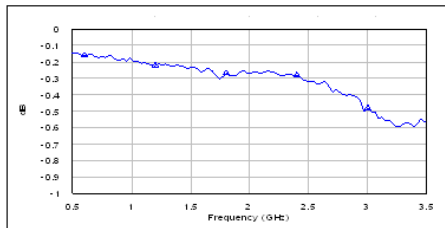

Return Loss

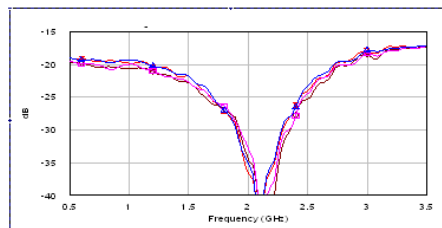

Part Identification

Marking

Pin 1
Mark



1st row Device code 'PES'

2nd row Trace Code to be assigned by SubCon

Pad Layout

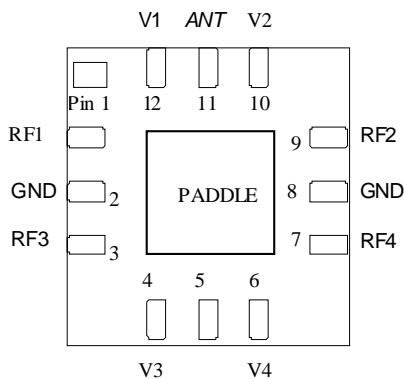

Pin	Name	Description
1	RF1	RF port 1
2	GND	Ground
3	RF3	RF port 3
4	V3	VCTRL3 (ANT to RF3)
5	NC	No connection
6	V4	VCTRL4 (ANT to RF4)
7	RF4	RF port 4
8	GND	Ground
9	RF2	RF port 2
10	V2	VCTRL2 (ANT to RF2)
11	ANT	Antenna
12	V1	VCTRL1 (ANT to RF1)
Paddle	Ground	

Package Drawing

QFN 12-Lead 3mmx3mm; NiPdAu finish for military and high reliability applications

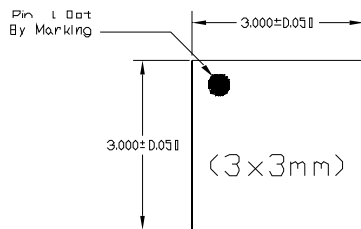

TOP VIEW

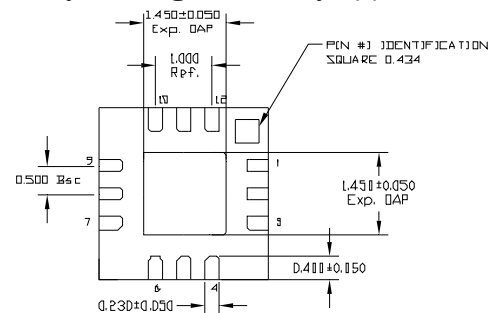

BOTTOM VIEW

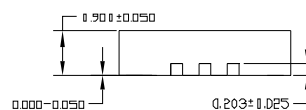

SIDE VIEW

Evaluation Board Layout

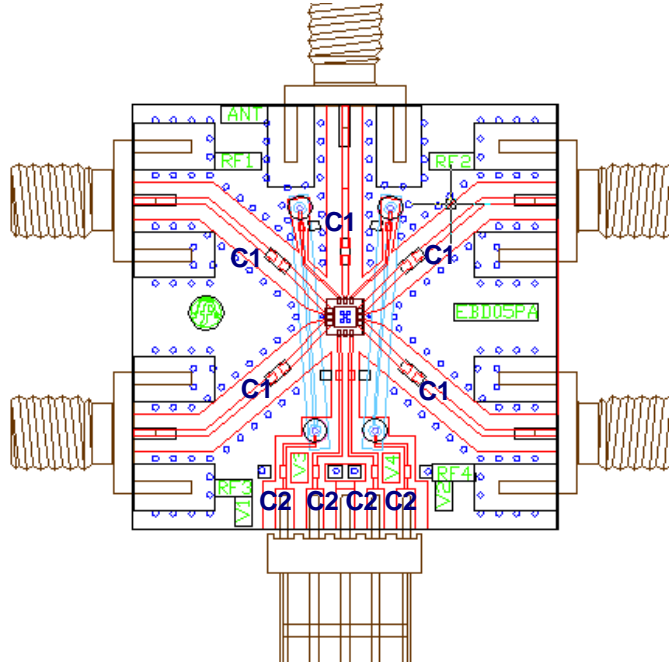

Bill of Materials

Label	Component
Board	Preferred evaluation board material is 0.25mm thick ROGERS RT4350. All RF tracks should be 50Ω characteristic impedance.
RFC	SMA RF connector
DCC	DC connector
C1	Capacitor, 47 pF, 0402
C2	Capacitor, 470 pF, 0603

Tape and Reel

Tape and reel information on this material is in accordance with EIA-481-1 except where exceptions are identified.

Preferred Assembly Instructions

This package is compatible with both lead-free and leaded solder reflow processes as defined within IPC/JEDEC J-STD-020. The maximum package temperature should not exceed 260 °C.

Handling Precautions



To avoid damage to the devices, care should be exercised during handling. Proper Electrostatic Discharge (ESD) precautions should be observed at all stages of storage, handling, assembly, and testing.

ESD Rating

These devices should be treated as Class 1A (250V to 500V) as defined in JEDEC Standard No. 22-A114. Further information on ESD control measures can be found in MIL-STD-1686 and MIL-HDBK-263.

MSL Rating

The device has an MSL rating of Level 1. To determine this rating, preconditioning was performed to the device per the Pb-Free solder profile defined within IPC/JEDEC J-STD-020, Moisture/Reflow sensitivity classification for non-hermetic solid state surface mount devices.

Application Notes and Design Data

Application Notes and design data, including S-parameters are available on request from www.rfmd.com.

Reliability

A MTTF in excess of 9 million hours at a channel temperature of 150 °C is achieved for the process used to manufacture this device.

Disclaimers

This product is not designed for use in any space-based or life-sustaining/supporting equipment.

Ordering Information

Ordering Code	Description
FMS2016-005	7" reel with 1000 pieces
FMS2016-005SR	7" reel with 100 pieces
FMS2016-005SQ	Sample bag with 25 pieces
FMS2016-005-EB	Packaged Die Mounted on Evaluation Board