

4

3

2

1

THIS DRAWING IS UNPUBLISHED. RELEASED FOR PUBLICATION
 © COPYRIGHT - By - ALL RIGHTS RESERVED.

LOC	DIST	REVISIONS					
		P	LTR	DESCRIPTION	DATE	DWN	APVD
HB	-	D		CHANGE LOGO, ADD CQC, LINE IDENTIFIER, PLATING THICKNESS ECO-12-005725	20-AUG-12	D.L	BH.Y

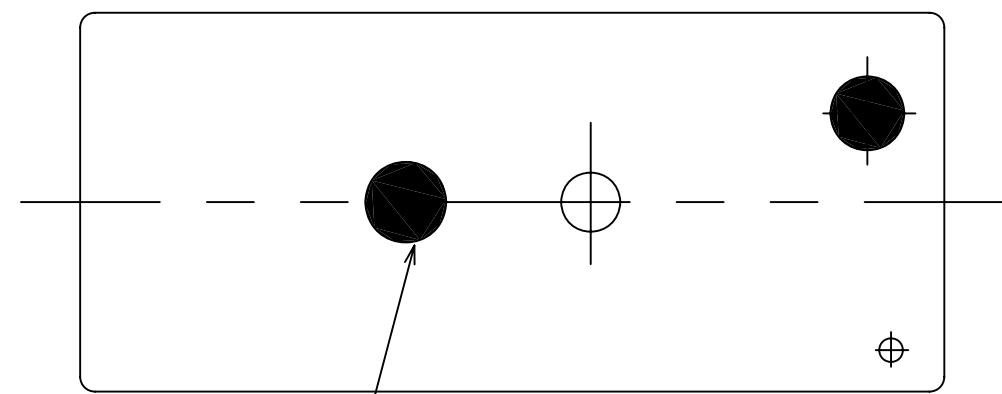

DOT MARK: PURPLE

(D) (C)

PART A

PART B

C:MADE IN CHINA

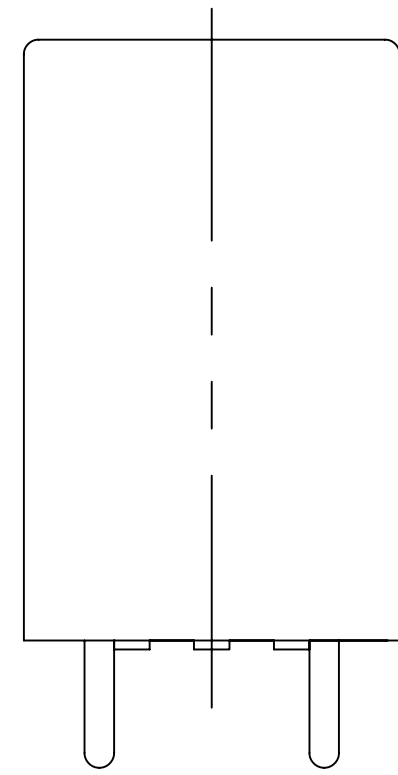
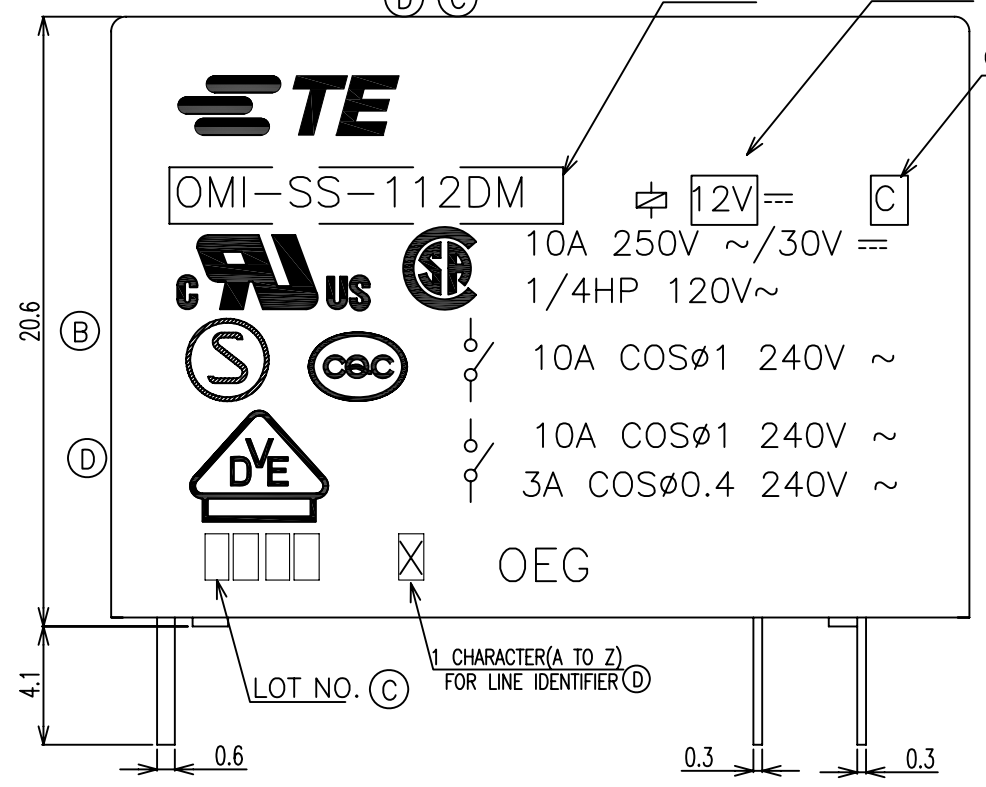

CONNECTION DIAGRAM (BOTTOM VIEW)

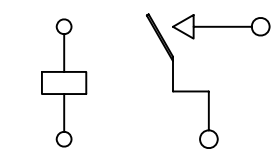

DRILLING DIAGRAM(2/1) (BOTTOM VIEW)

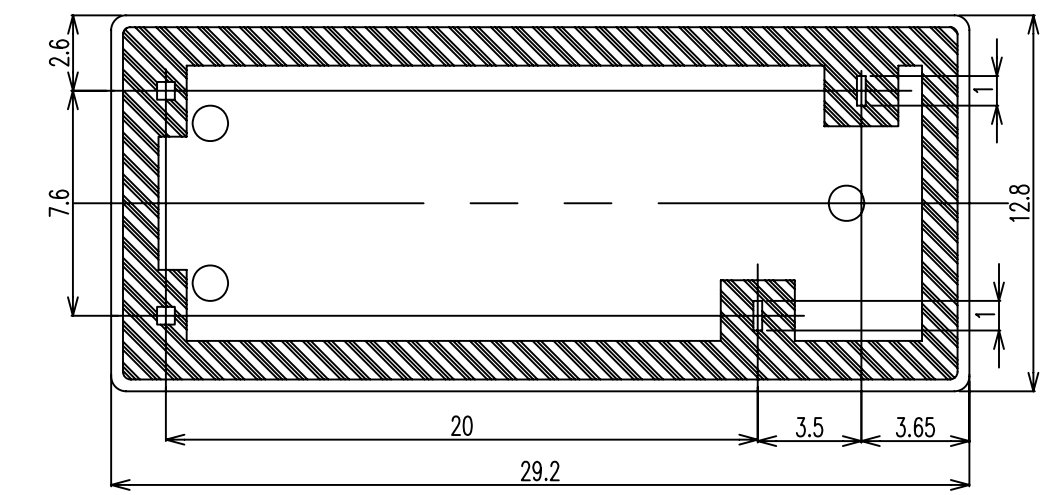
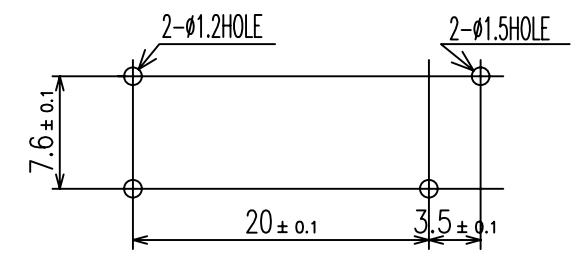

THIS DRAWING IS A CONTROLLED DOCUMENT.		DWN H.SASAKI	TE Connectivity	
DIMENSIONS: mm		CHK -		
TOLERANCES UNLESS OTHERWISE SPECIFIED:		APVD Y.OIKAWA	NAME -	
0 PLC ± -		PRODUCT SPEC	OMI-1M,394 CUSTOMER DRAWING	
1 PLC ± -		A.NAGAI	-	
2 PLC ± -		APPLICATION SPEC	SIZE	CAGE CODE
3 PLC ± -		-	A3	00779
4 PLC ± -		WEIGHT	DRAWING NO	
ANGLES ± -		-	C-3-1440000-9	
FINISH		CUSTOMER DRAWING	RESTRICTED TO	-
-		SCALE	SHEET	
-		4:1	1 of 2	
-		REV	D	

4

3

2

1

THIS DRAWING IS UNPUBLISHED. RELEASED FOR PUBLICATION
 © COPYRIGHT - By - ALL RIGHTS RESERVED.

LOC	DIST	REVISIONS			
P	LTR	DESCRIPTION	DATE	DWN	APVD
HB	-				

NOTES:
 1.-SH- : WASHABLE TYPE
 ③ 2.LOT NO. SYSTEM AS FOLLOWING:
 0701 WEEK YEAR
 3.GENERAL TOLERANCE AS FOLLOWING:

TOLERANCE	
MAX .1mm	±0.1
1mm~MAX.3mm	±0.2
3mm MIN.	±0.3

④ 4.FOR THE TIN-PLATING OF THE PINS:
 +0.1mm FOR WIDTH,THICKNESS AND DIAMETER.
 +0.5mm FOR LENGTH.

4-1440000-4	OMI-SH-124LM	24V	OMI-SH-124LM
4-1440000-1	OMI-SH-112LM	12V	OMI-SH-112LM
3-1440000-9	OMI-SH-112DM	12V	OMI-SH-112DM
TE PART NO	DESCRIPTION	PART B	PART A

RELAY TYPE

INCOMBUSTIBILITY	TREATMENT	MATERIAL	DESCRIPTION	ITEM
		UV RESIN	UV SEAL	16
		EPOXY RESIN	SEAL	15
UL94 V-0		PBT	CASE	14
CLASS E		UEW	MAGNETIC WIRE	13
UL94 V-0		PET	BASE	12
UL94 V-0		PBT	BOBBIN	11
	SOLDER DIP	CP WIRE	COIL TERMINAL	10
UL94 V-0		PPS	CARD	9
		Ag ALLOY	MOVABLE CONTACT	8
		Ag ALLOY	STATIONARY CONTACT	7
		Cu ALLOY	HINGE SPRING	6
	SOLDER DIP	Cu ALLOY	STATIONARY TERMINAL	5
	SOLDER DIP	Cu ALLOY	MOVABLE SPRING	4
		STEEL	CORE	3
		STEEL	ARMATURE	2
		STEEL	YOKE	1

THIS DRAWING IS A CONTROLLED DOCUMENT.		DWN H.SASAKI	 TE Connectivity		
DIMENSIONS: mm		CHK -			
TOLERANCES UNLESS OTHERWISE SPECIFIED:		APVD Y.OIKAWA	NAME -		
0 PLC ± -		PRODUCT SPEC A.NAGAI	OMI-1M,394 CUSTOMER DRAWING		
1 PLC ± -		APPLICATION SPEC -	SIZE A3	CAGE CODE 00779	DRAWING NO 3-1440000-9
2 PLC ± -		WEIGHT -	RESTRICTED TO -		
3 PLC ± -		CUSTOMER DRAWING	SCALE 4:1	SHEET 2 of 2	REV D
4 PLC ± -					
ANGLES ± -					
FINISH -					