

# Panasonic

ideas for life

Space reduction down  
to footprint of  
5.6 mm × 14 mm<sup>2</sup> realized

## TN RELAYS



RoHS compliant

### FEATURES

- 2 Form C Slim type**  
14.0(L) × 9.0(W) × 5.0(H) .551(L) × .354(W) × .197(H)  
Small header area makes higher density mounting possible
- Nominal operating power: High sensitivity of 140mW (Single side stable type)**  
By using the highly efficient polar magnetic circuit "seesaw balance mechanism", a nominal operating power of 140 mW (minimum operating power of 79 mW) has been achieved.
- Surge breakdown voltage: 1500 V FCC Part 68**
- Outstanding vibration and shock resistance.**  
Functional shock resistance: 490 m/s<sup>2</sup>  
Destructive shock resistance: 980 m/s<sup>2</sup>  
Functional vibration resistance:  
10 to 55 Hz (at double amplitude of 3 mm .118 inch)  
Destructive vibration resistance:  
10 to 55 Hz (at double amplitude of 5 mm .197 inch)
- High density mounting possible**  
High-efficiency magnetic circuits ensure low magnetic flux leakage.  
Because characteristics are little changed by proximity mounting, high-density mounting is possible.
- The use of gold-clad twin crossbar contacts ensures high contact reliability.**  
\*We also offer a range of products TX/TX-S/TX-D relay with AgPd contacts suitable for use in low level load analog circuits (Max. 10V DC 10 mA).
- Low thermal electromotive force**  
As well as low power consumption of 140 mW, use of a structure with separate coil and contact sections has reduced thermal electromotive force to the low level of approximately 5 μV.
- Latching types also available**
- Self-clinching terminal also available**
- Sealed construction allows automatic washing.**

### TYPICAL APPLICATIONS

- Communications
- Measurement equipment
- OA equipment
- Industrial machines

### ORDERING INFORMATION

TN 2 - [ ] - [ ] - [ ]

Contact arrangement  
2: 2 Form C

Operating function  
Nil: Single side stable  
L: 1 coil latching  
L2: 2 coil latching

Terminal shape  
Nil: Standard PC board terminal  
H: Self-clinching terminal

Nominal coil voltage (DC)\*  
3, 4.5, 5, 6, 9, 12, 24, 48V

Notes: 1. \*48 V coil type: Single side stable only  
2. In case of 5 V drive circuit, it is recommended to use 4.5 V type relay.



**Discontinued**  
Last time buy: August 31, 2013

TN

## TYPES

### 1. Standard PC board terminal

Contact arrangement	Nominal coil voltage	Single side stable	1 coil latching	2 coil latching
		Part No.	Part No.	Part No.
2 Form C	3V DC	TN2-3V	TN2-L-3V	TN2-L2-3V
	4.5V DC	TN2-4.5V	TN2-L-4.5V	TN2-L2-4.5V
	5V DC	TN2-5V	TN2-L-5V	TN2-L2-5V
	6V DC	TN2-6V	TN2-L-6V	TN2-L2-6V
	9V DC	TN2-9V	TN2-L-9V	TN2-L2-9V
	12V DC	TN2-12V	TN2-L-12V	TN2-L2-12V
	24V DC	TN2-24V	TN2-L-24V	TN2-L2-24V
	48V DC	TN2-48V	—	—

Standard packing: Tube: 50 pcs.; Case: 1,000 pcs.

### 2. Self-clinching terminal

Contact arrangement	Nominal coil voltage	Single side stable	1 coil latching	2 coil latching
		Part No.	Part No.	Part No.
2 Form C	3V DC	TN2-H-3V	TN2-L-H-3V	TN2-L2-H-3V
	4.5V DC	TN2-H-4.5V	TN2-L-H-4.5V	TN2-L2-H-4.5V
	5V DC	TN2-H-5V	TN2-L-H-5V	TN2-L2-H-5V
	6V DC	TN2-H-6V	TN2-L-H-6V	TN2-L2-H-6V
	9V DC	TN2-H-9V	TN2-L-H-9V	TN2-L2-H-9V
	12V DC	TN2-H-12V	TN2-L-H-12V	TN2-L2-H-12V
	24V DC	TN2-H-24V	TN2-L-H-24V	TN2-L2-H-24V
	48V DC	TN2-H-48V	—	—

Standard packing: Tube: 50 pcs.; Case: 1,000 pcs.

Note: Types ("3" to the end of part No.) designed to withstand strong vibration caused, for example, by the use of terminal cutters, can also be ordered. However, please contact us if you need parts for use in low level load and low thermal power.

## RATING

### 1. Coil data

#### 1) Single side stable

Nominal coil voltage	Pick-up voltage (at 20°C 68°F)	Drop-out voltage (at 20°C 68°F)	Nominal operating current [±10%] (at 20°C 68°F)	Coil resistance [±10%] (at 20°C 68°F)	Nominal operating power	Max. applied voltage (at 20°C 68°F)
3V DC	75%V or less of nominal voltage* (Initial)	10%V or more of nominal voltage* (Initial)	46.7mA	64.3Ω	140mW	150%V of nominal voltage
4.5V DC			31.1mA	145Ω		
5V DC			28.1mA	178Ω		
6V DC			23.3mA	257Ω		
9V DC			15.5mA	579Ω		
12V DC			11.7mA	1,028Ω	200mW	
24V DC			8.3mA	2,880Ω		
48V DC			6.25mA	7,680Ω	300mW	120%V of nominal voltage

#### 2) 1 coil latching

Nominal coil voltage	Set voltage (at 20°C 68°F)	Reset voltage (at 20°C 68°F)	Nominal operating current [±10%] (at 20°C 68°F)	Coil resistance [±10%] (at 20°C 68°F)	Nominal operating power	Max. applied voltage (at 20°C 68°F)
3V DC	75%V or less of nominal voltage* (Initial)	75%V or less of nominal voltage* (Initial)	33.3mA	90Ω	100mW	150%V of nominal voltage
4.5V DC			22.2mA	202.5Ω		
5V DC			20mA	250Ω		
6V DC			16.7mA	360Ω		
9V DC			11.1mA	810Ω		
12V DC			8.3mA	1,440Ω	150mW	
24V DC			6.3mA	3,840Ω		



## 3) 2 coil latching

Nominal coil voltage	Set voltage (at 20°C 68°F)	Reset voltage (at 20°C 68°F)	Nominal operating current [±10%] (at 20°C 68°F)		Coil resistance [±10%] (at 20°C 68°F)		Nominal operating power		Max. applied voltage (at 20°C 68°F)
			Set coil	Reset coil	Set coil	Reset coil	Set coil	Reset coil	
3V DC	75%V or less of nominal voltage* (Initial)	75%V or less of nominal voltage* (Initial)	66.7mA	66.7mA	45Ω	45Ω	200mW	200mW	150%V of nominal voltage
4.5V DC			44.4mA	44.4mA	101.2Ω	101.2Ω			
5V DC			40mA	40mA	125Ω	125Ω			
6V DC			33.3mA	33.3mA	180Ω	180Ω			
9V DC			22.2mA	22.2mA	405Ω	405Ω			
12V DC			16.7mA	16.7mA	720Ω	720Ω			
24V DC			12.5mA	12.5mA	1,920Ω	1,920Ω	300mW	300mW	120%V of nominal voltage

\*Pulse drive (JIS C 5442-1986)

## 2. Specifications

Characteristics	Item	Specification	
Contact	Arrangement	2 Form C	
	Initial contact resistance, max.	Max. 60 mΩ (By voltage drop 6 V DC 1A)	
	Contact material	Ag+Au clad	
Rating	Nominal switching capacity	1 A 30 V DC, 0.5 A 125 V AC (resistive load)	
	Max. switching power	30 W (DC), 62.5 VA (AC) (resistive load)	
	Max. switching voltage	110 V DC, 125 V AC	
	Max. switching current	1 A	
	Min. switching capacity (Reference value)*1	10μA 10mV DC	
	Nominal operating power	Single side stable 1 coil latching 2 coil latching	140 mW (3 to 12 V DC), 200 mW (24 V DC), 300 mW (48 V DC) 100 mW (3 to 12 V DC), 150 mW (24 V DC) 200 mW (3 to 12 V DC), 300 mW (24 V DC)
Electrical characteristics	Insulation resistance (Initial)	Min. 1,000MΩ (at 500V DC) Measurement at same location as "Initial breakdown voltage" section.	
	Breakdown voltage (Initial)	Between open contacts	750 Vrms for 1 min. (Detection current: 10 mA)
		Between contact and coil	1,000 Vrms for 1 min. (Detection current: 10 mA)
		Between contact sets	1,000 Vrms for 1 min. (Detection current: 10 mA)
	Surge breakdown voltage (Initial)	Between open contacts	1,500 V (10×160μs) (FCC Part 68)
	Temperature rise (at 20°C 68°F)		Max. 50°C (By resistive method, nominal coil voltage applied to the coil; contact carrying current: 1A.)
Operate time [Set time] (at 20°C 68°F)		Max. 3 ms [Max. 3 ms] (Nominal coil voltage applied to the coil, excluding contact bounce time.)	
Release time [Reset time] (at 20°C 68°F)		Max. 3 ms [Max. 3 ms] (Nominal coil voltage applied to the coil, excluding contact bounce time.) (without diode)	
Mechanical characteristics	Shock resistance	Functional	Min. 490 m/s <sup>2</sup> (Half-wave pulse of sine wave: 11 ms; detection time: 10μs.)
		Destructive	Min. 980 m/s <sup>2</sup> (Half-wave pulse of sine wave: 6 ms.)
	Vibration resistance	Functional	10 to 55 Hz at double amplitude of 3 mm (Detection time: 10μs.)
		Destructive	10 to 55 Hz at double amplitude of 5 mm
Expected life	Mechanical	Min. 10 <sup>8</sup> (at 180 cpm)	
	Electrical	Min. 2×10 <sup>5</sup> (1 A 30 V DC resistive), Min. 10 <sup>5</sup> (0.5 A 125 V AC resistive) (at 20 cpm)	
Conditions	Conditions for operation, transport and storage*2	Ambient temperature: -40°C to 70°C -40°F to 158°F; Humidity: 5 to 85% R.H. (Not freezing and condensing at low temperature)	
	Max. operating speed (at rated load)	20 cpm	
Unit weight		Approx. 1.5 g .053 oz	

Notes: \*1 This value can change due to the switching frequency, environmental conditions, and desired reliability level, therefore it is recommended to check this with the actual load. (TX/TX-S/TX-D relay AgPd contact type are available for low level load switching [10V DC, 10mA max. level])

\*2 Refer to 6. Conditions for operation, transport and storage mentioned in AMBIENT ENVIRONMENT.



**Discontinued**  
Last time buy: August 31, 2013

TN

## REFERENCE DATA

### 1. Maximum switching capacity

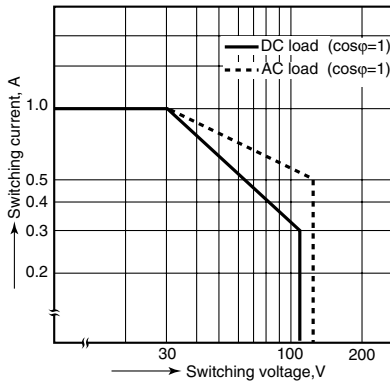

### 2. Life curve

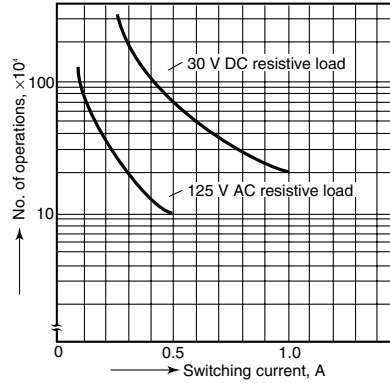

### 3. Mechanical life

Tested sample: TN2-12V, 10 pcs.

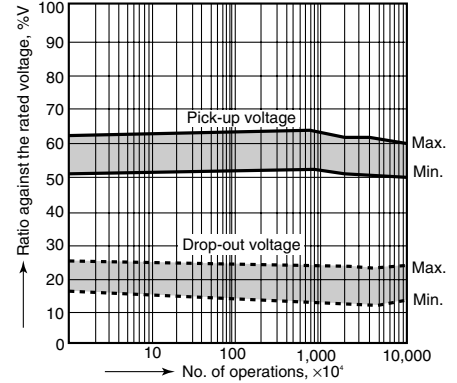

### 4. Electrical life (DC load)

Tested sample: TN2-12V, 10 pcs.

Condition: 1 A 30 V DC resistive load, 20 cpm

#### Change of pick-up and drop-out voltage

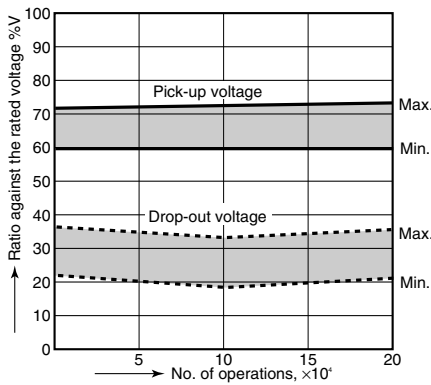

#### Change of contact resistance

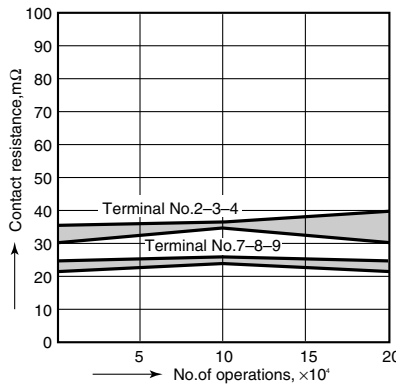

### 5. Coil temperature rise

Tested sample: TN2-12V

Point measured: Inside the coil

Ambient temperature: Room temperature (25° to 26°C), 70°C (77° to 79°F), 158°F

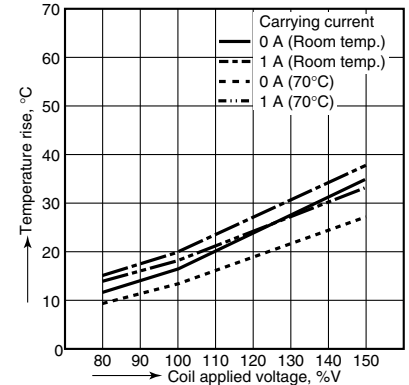

### 6. Set/reset time characteristics

Tested sample: TN2-L2-12V, 5 pcs.

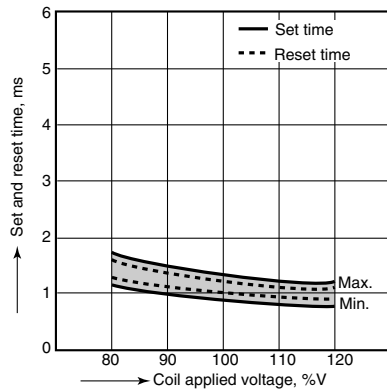

### 7. Ambient temperature characteristics

Tested sample: TN2-12V, 5 pcs.

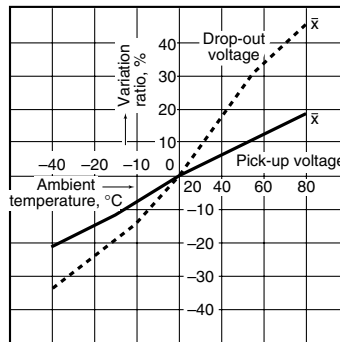

### 8-(1). Malfunctional shock (single side stable)

Tested sample: TN2-12V, 6 pcs.

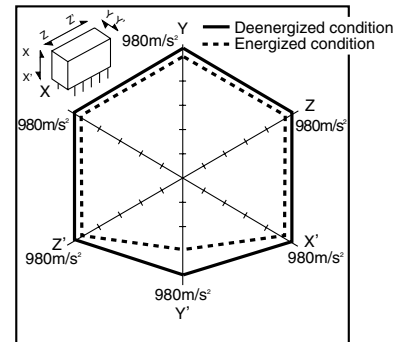

### 8-(2). Malfunctional shock (latching)

Tested sample: TN2-L2-12V, 6 pcs.

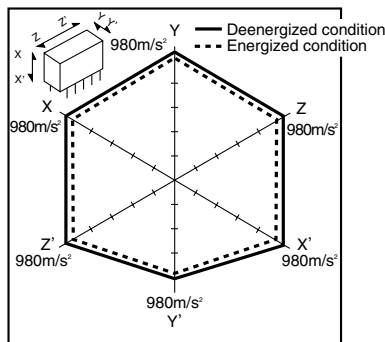

### 9-(1). Influence of adjacent mountin

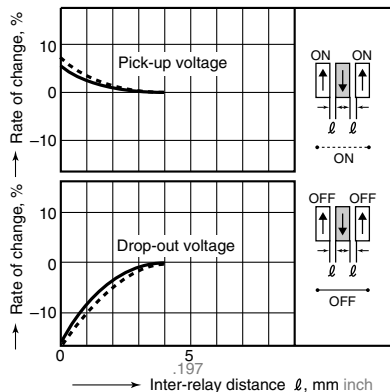

### 9-(2). Influence of adjacent mountin

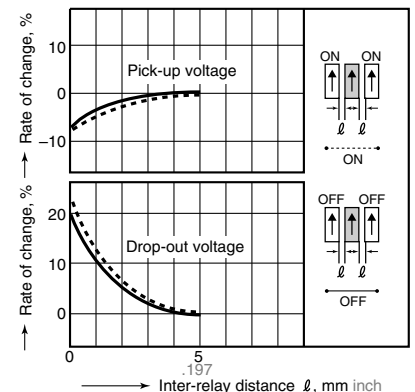

10. Actual load test (35 mA 48 V DC wire spring relay load)

Tested sample: TN2-12V, 5 pcs.

Change of pick-up and drop-out voltage

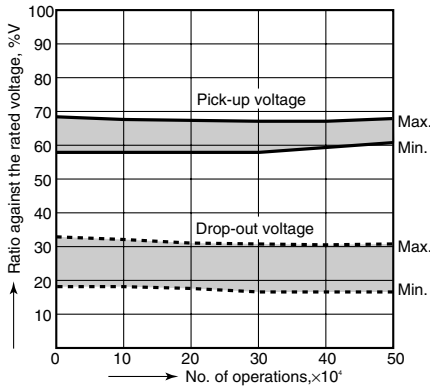

Change of contact resistance

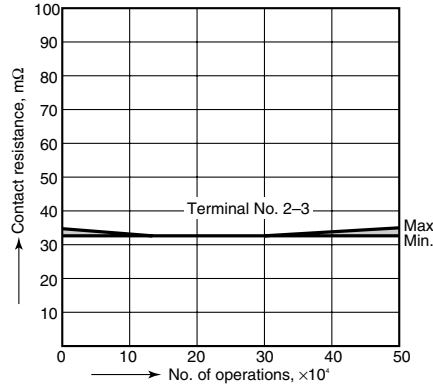

**DIMENSIONS** (mm inch)

The CAD data of the products with a **CAD Data** mark can be downloaded from: <http://industrial.panasonic.com/ac/e>

**CAD Data**

External dimensions

Standard PC board terminal

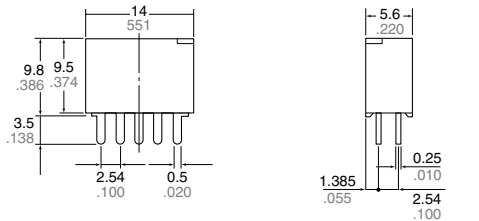

PC board pattern (Bottom view)

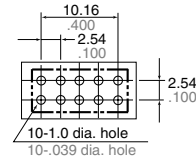

Tolerance:  $\pm 0.1 \pm .004$

Self-clinching terminal

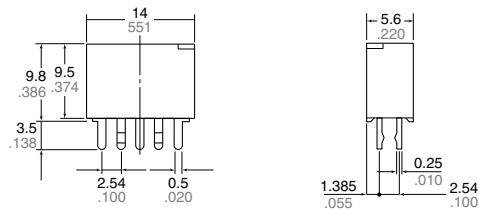

General tolerance:  $\pm 0.3 \pm .012$

Schematic (Bottom view)

Single side stable

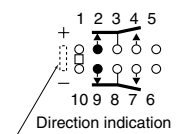

(Deenergized condition)

1-coil latching

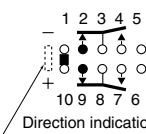

(Reset condition)

2-coil latching

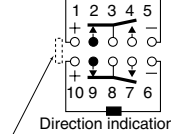

(Reset condition)

**NOTES**

1. Packing style

The relay is packed in a tube with the relay orientation mark on the left side, as shown in the figure below.

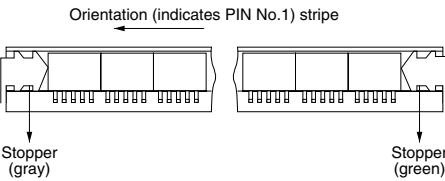

2. Automatic insertion

To maintain the internal function of the relay, the chucking pressure should not exceed the values below.

Chuckling pressure in the direction A:

9.8 N {1 kgf} or less

Chuckling pressure in the direction B:

9.8 N {1 kgf} or less

Chuckling pressure in the direction C:

4.9 N {500gf} or less

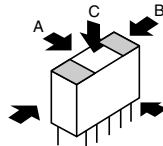

Please chuck the  portion.  
Avoid chucking the center of the relay.  
In addition, excessive chucking pressure to the pinpoint of the relay should be avoided.

**For general cautions for use, please refer to the "Cautions for use of Signal Relays" or "General Application Guidelines".**