



Panasonic
ideas for life

Non-polarized 1 Form C
relay that realizes nominal
operating power of 150 mW

HY RELAYS



RoHS compliant

FEATURES

- Nominal operating power:**
High sensitivity of 150mW (Single side stable type)
A nominal operating power of 150 mW (minimum operating power of 84 mW) has been achieved.
- The use of gold-clad twin contacts ensures high contact reliability.**
- Sealed construction**

TYPICAL APPLICATIONS

- Automotive equipment**
Automirror controller
Retractable head light controller
- Push button device: Dial pulsing**
- Portable video tape recorders and audio devices.**
- Computer peripherals**

ORDERING INFORMATION

HY 1 -

Contact arrangement

1: 1 Form C

Sensitivity

Nil: High sensitivity 150 mW

Z: Standard 200 mW

Nominal coil voltage (DC)

1.5, 3, 4.5, 5, 6, 9, 12, 24 V

Note: In case of 5 V drive circuit, it is recommended to use 4.5 V type relay.

TYPES

Contact arrangement	Nominal coil voltage	150mW type	200mW type
		Part No.	Part No.
1 Form C	1.5V DC	HY1-1.5V	HY1Z-1.5V
	3V DC	HY1-3V	HY1Z-3V
	4.5V DC	HY1-4.5V	HY1Z-4.5V
	5V DC	HY1-5V	HY1Z-5V
	6V DC	HY1-6V	HY1Z-6V
	9V DC	HY1-9V	HY1Z-9V
	12V DC	HY1-12V	HY1Z-12V
	24V DC	HY1-24V	HY1Z-24V

Standard packing: Tube: 50 pcs.; Case: 2,000 pcs.

RATING

1. Coil data

Contact arrangement	Nominal coil voltage	Pick-up voltage (at 20°C 68°F)	Drop-out voltage (at 20°C 68°F)	Nominal operating current [±10%] (at 20°C 68°F)	Coil resistance [±10%] (at 20°C 68°F)	Nominal operating power	Max. applied voltage (at 70°C 158°F)
1 Form C	1.5V DC	75%V or less of nominal voltage (Initial)	10%V or more of nominal voltage (Initial)	100mA	15Ω	150mW	140%V of nominal voltage
	3V DC			50mA	60Ω		
	4.5V DC			33.3mA	135Ω		
	5V DC			30mA	166Ω		
	6V DC			25mA	240Ω		
	9V DC			16.7mA	540Ω		
	12V DC			12.5mA	960Ω		
	24V DC			6.25mA	3,840Ω		
	1.5V DC	75%V or less of nominal voltage (Initial)	10%V or more of nominal voltage (Initial)	133.3mA	11.25Ω	200mW	120%V of nominal voltage
	3V DC			66.7mA	45Ω		
	4.5V DC			44.5mA	101.2Ω		
	5V DC			40mA	125Ω		
	6V DC			33.3mA	180Ω		
	9V DC			22.2mA	405Ω		
	12V DC			16.7mA	720Ω		
	24V DC			8.3mA	2,880Ω		

2. Specifications

Characteristics	Item	Specifications	
Contact	Arrangement	1 Form C	
	Initial contact resistance, max.	Max. 100 mΩ (By voltage drop 6 V DC 1A)	
	Contact material	Ag+Au clad	
Rating	Nominal switching capacity	1 A 30 V DC (resistive load)	
	Max. switching power	30 W (DC) (resistive load)	
	Max. switching voltage	60 V DC	
	Max. carrying current	2 A	
	Max. switching current	1 A (30 V DC)	
	Min. switching capacity (Reference value)*1	1mA 1 V DC	
	Nominal operating power	150/200mW	
Electrical characteristics	Insulation resistance (Initial)	Min. 100MΩ (at 500V DC) Measurement at same location as "Initial breakdown voltage" section.	
	Breakdown voltage (Initial)	Between open contacts	500 Vrms for 1min. (Detection current: 10mA)
		Between contact and coil	1,000 Vrms for 1min. (Detection current: 10mA)
	Temperature rise (at 20°C 68°F)	Max. 50°C (By resistive method, nominal coil voltage applied to the coil, nominal switching capacity.)	
	Operate time [Set time] (at 20°C 68°F)	Max. 5 ms (Nominal coil voltage applied to the coil, excluding contact bounce time.)	
	Release time [Reset time] (at 20°C 68°F)	Max. 4 ms (Nominal coil voltage applied to the coil, excluding contact bounce time.) (without diode)	
Mechanical characteristics	Shock resistance	Functional	Min. 98 m/s ² (Half-wave pulse of sine wave: 11 ms; detection time: 10μs.)
		Destructive	Min. 980 m/s ² (Half-wave pulse of sine wave: 6 ms.)
	Vibration resistance	Functional	10 to 55 Hz at double amplitude of 1 mm (Detection time: 10μs.)
		Destructive	10 to 55 Hz at double amplitude of 2 mm
Expected life	Mechanical	Min. 10 ⁷ (at 180 cpm)	
	Electrical	Min. 10 ⁵ (1 A 30 V DC resistive) (at 20 cpm)	
Conditions	Conditions for operation, transport and storage*2	Ambient temperature: -40°C to +70°C -40°F to +158°F Humidity: 5 to 85% R.H. (Not freezing and condensing at low temperature)	
	Max. operating speed (at rated load)	20 cpm	
Unit weight		Approx. 1.8 g .063 oz	

Notes: *1 This value can change due to the switching frequency, environmental conditions, and desired reliability level, therefore it is recommended to check this with the actual load.

*2 Refer to 6. Conditions for operation, transport and storage mentioned in AMBIENT ENVIRONMENT.

REFERENCE DATA

1. Maximum switching power

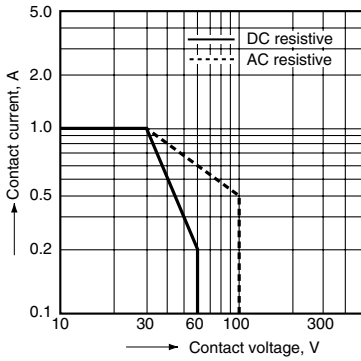

2. Life curve

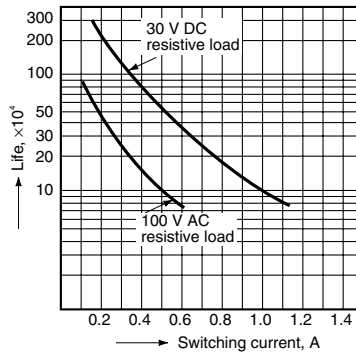

3. Mechanical life

Tested sample: HY1Z-12V, 10 pcs.
Ambient temperature: 20°C to 25°C 68°F to 77°F

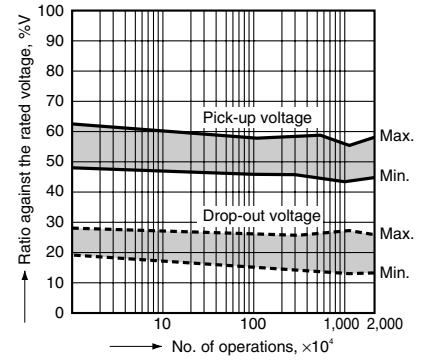

4. Electrical life

Tested sample: HY1-12V, 6 pcs.
Condition: 1 A 30 V DC resistive load, 30 cpm

Change of pick-up and drop-out voltage

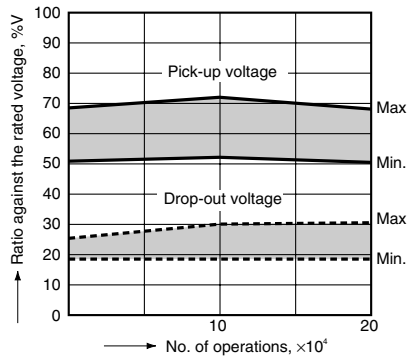

Change of contact resistance

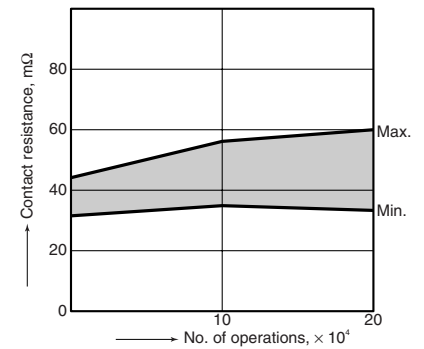

5-(1). Coil temperature rise (150 mW high sensitivity type)

Tested sample: HY1-9V, 5 pcs.
Ambient temperature: 24°C 75°F

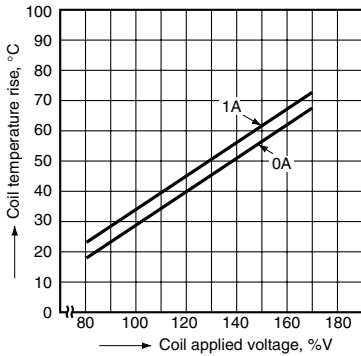

5-(2). Coil temperature rise (200 mW Standard type)

Tested sample: HY1Z-12V, 5 pcs.
Ambient temperature: 23°C 74°F

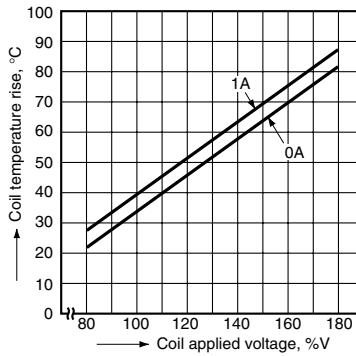

6. Operate/release time characteristics

Tested sample: HY1Z-12V, 5 pcs.
Ambient temperature: 25°C 77°F

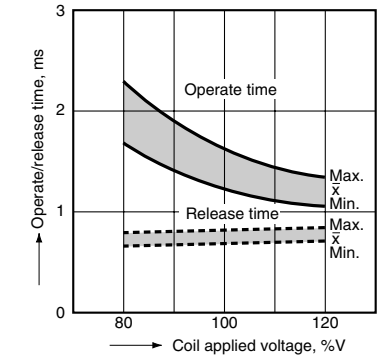

7. Distribution of pick-up and drop-out voltages

Tested sample: HY1-12V, 50 pcs.
Ambient temperature: 23°C 74°F

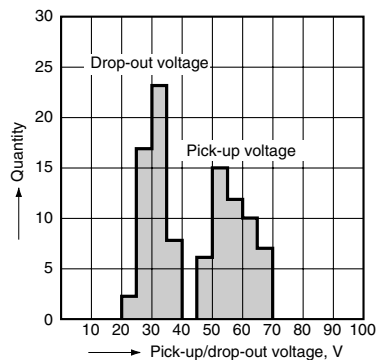

8. Distribution of contact resistance

Tested sample: HY1-12V, 50 pcs.
N.C. side N.O. side

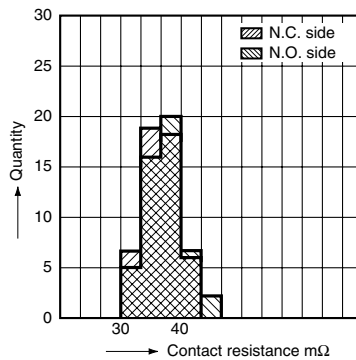

9. Malfunction shock

Tested sample: HY1Z-12V, 6 pcs.

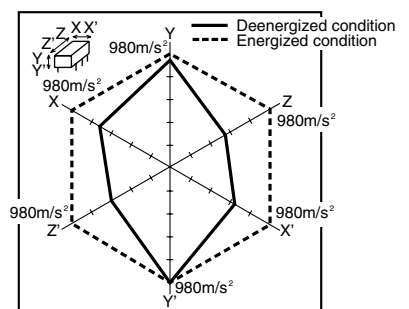

DIMENSIONS (mm inch)

The CAD data of the products with a **CAD Data** mark can be downloaded from: <http://panasonic-electric-works.net/ac>

CAD Data



External dimensions

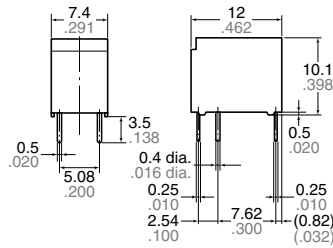

PC board pattern (Bottom view)

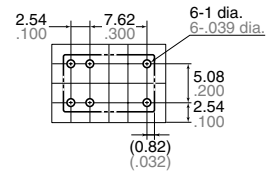

Tolerance: $\pm 0.1 \pm 0.004$

General tolerance: $\pm 0.3 \pm 0.012$

Schematic (Bottom view)

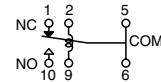

NOTE

1. Packing style

1) As shown in the diagram below, the relays are presented in tube packages with pins 1 and 10 on the left. Be sure to maintain relays in the correct orientation when mounting on PC boards.

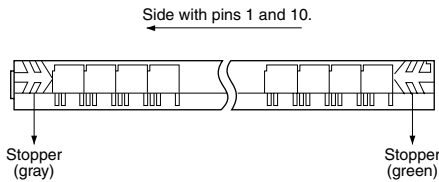

2. Automatic insertion

To maintain the internal function of the relay, the chucking pressure should not exceed the values below.

- Chucking pressure in the direction A: 4.9 N {500gf} or less
- Chucking pressure in the direction B: 4.9 N {500gf} or less
- Chucking pressure in the direction C: 4.9 N {500gf} or less

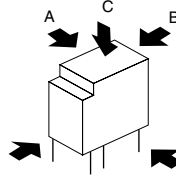

Avoid chucking the center of the relay. In addition, excessive chucking pressure to the pinpoint of the relay should be avoided.

For general cautions for use, please refer to the "Cautions for use of Signal Relays" or "General Application Guidelines".