

# Open Air Resistor Metal Element Current Sense

## OAR Series

- TCR's to  $\pm 20\text{ppm}/^\circ\text{C}$
- Power ratings of 1, 3, & 5W @  $85^\circ\text{C}$
- Resistance range from  $2.5\text{m}\Omega$  to  $100\text{m}\Omega$
- Open air design maximizes thermal performance
- Welded copper leads minimize effects from solder wicking and provide true 1% performance



### Features:

- Welded construction
- Flameproof
- Inductance less than 10 nanohenries
- Solderable copper leads (60/40) and Lead-Free

### Applications:

- Current sensing
- Feedback
- Motor Controllers
- Power Supplies

## Electrical Data

Part Number	Power Rating @ $85^\circ\text{C}$ (watts)	Resistance Range ( $\text{m}\Omega$ )	Tolerance ( $\pm\%$ )	TCR ( $\pm\text{ppm}/^\circ\text{C}$ )	Inductance (nH)
OAR-1	1.0	3, 5, 10, *20, *25, 50	1, 2 <sup>1</sup> , 5	20	<10
OAR-3	3.0	2.5, 5, 10, 15, 20, 25, *30, 50, 100			
OAR-5	5.0	3, 5, 10, *15, *20, *25, *50			

#### Notes:

- <sup>1</sup>  $\pm 2\%$  tolerance available  $<5\text{m}\Omega$
- \* denotes resistance values that may have longer lead times than other values listed
- \* Please contact factory for resistance values not listed

## Environmental Data

Load Life (1000 hours @ $25^\circ\text{C}$ )	$\Delta R/R < 1\%$
Moisture (no load for 1000 hours)	$\Delta R/R < 1\%$
Temperature Cycling ( $-40^\circ\text{C}$ to $+125^\circ\text{C}$ for 1000 cycles)	$\Delta R/R < 1\%$
Operating Temperature	$-40^\circ\text{C}$ to $+125^\circ\text{C}$

### General Note

TT electronics reserves the right to make changes in product specification without notice or liability. All information is subject to TT electronics' own data and is considered accurate at time of going to print.

## Physical Data

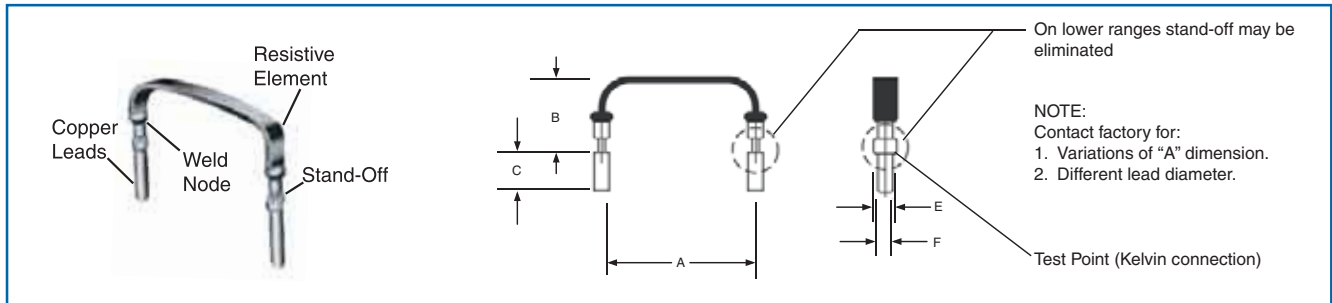

Dimensions (Inches and (mm))

IRC Type	A	B	C	E	F
<b>OAR-1</b>	0.450 +0.040/-0.020 (11.43 +1.020/-0.508)	0.27 Typ 0.32 (8.12) max	0.125 ±0.030 (3.18 ±0.762)	0.065 +0.010/-0.005 (1.65 +0.254/-0.127)	0.040 ±0.002 (1.02 ±0.051)
<b>OAR-3</b>	0.600 +0.040/-0.020 (15.24 +1.020/-0.508)	0.65 Typ 0.92 (23.4) max	0.125 ±0.030 (3.18 ±0.762)	0.065 +0.010/-0.005 (1.65 +0.254/-0.127)	0.040 ±0.002 (1.02 ±0.051)
<b>OAR-5</b>	0.800 +0.040/-0.020 (20.32 +1.020/-0.508)	0.65 Typ 0.88 (22.4) max	0.125 ±0.030 (3.18 ±0.762)	0.065 +0.010/-0.005 (1.65 +0.254/-0.127)	0.040 ±0.002 (1.02 ±0.051)

## Thermal Image Data

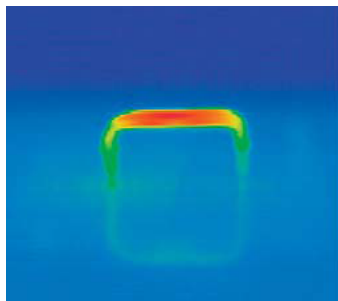

**OAR-1 5 mΩ @ 1 Watt**

Hot Spot: 87°C  
Solder Joint: 45°C

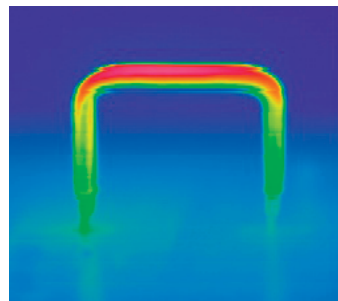

**OAR-3 5 mΩ @ 3 Watt**

Hot Spot: 160°C  
Solder Joint: 70°C

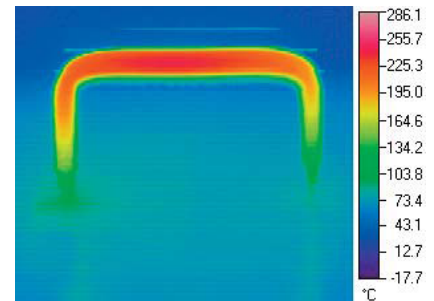

**OAR-5 5 mΩ @ 5 Watt**

Hot Spot: 230°C  
Solder Joint: 96°C

The thermal images (not simulations) above are of the OARs products at their respective power rating. Notice the solder joint temperature is much lower than the hotspot. The unique construction of the OAR isolates the temperature of the hotspot from the circuit board material preventing damage to the circuit board. Additionally, the thermal energy is dissipated to the air instead of being conducted into the circuit board potentially causing a nearby power component to exceed its rating.

The standard test circuit board consists of a four layer FR4 material with 2 ounce outer layers and 1 ounce inner layers, which is typical of many industry designs. The test conditions were in ambient temperature conditions, approximately 72 °C with no forced air. Contact IRC for more details or for other thermal image test data for specific resistance values and power levels.

### General Note

TT electronics reserves the right to make changes in product specification without notice or liability. All information is subject to TT electronics' own data and is considered accurate at time of going to print.

## Power Derating

The typical power derating curves are based on conservative design concepts that extend from film based products. The OAR is a solid metal alloy construction that can withstand comparably greater operating power levels than conservative design models permit. Typically the resistive alloys can withstand temperatures in excess of 300°C. Therefore, system thermal design considerations are a more significant design parameter due to the heat limitations of solder joints and/or circuit board substrate materials.

## Pulse/Surge Chart @ 50 msec duration

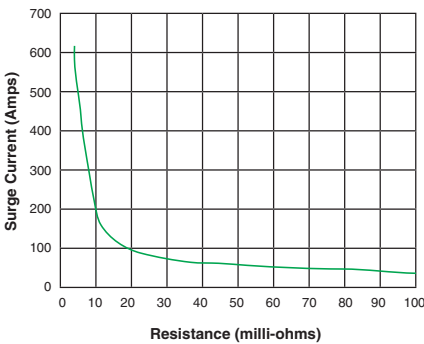

OAR-1

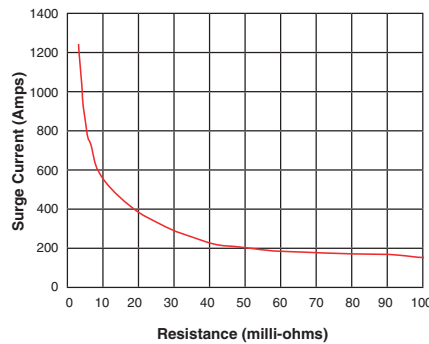

OAR-3

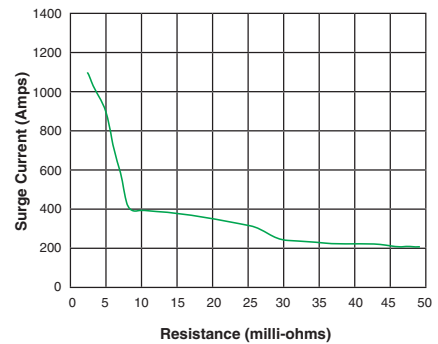

OAR-5

The Surge current charts are approximations of the capabilities of the OAR product and should not be used to the exclusion of actual testing. The relative high surge currents depicted in the charts are as a result of the robust all metal welded construction and the heat carrying capability of metal. Additionally the OAR resistive wire provides large relative cross section for current flow as compared to other resistor technologies, such as thin film, thick film, or metal strip.

## Ordering Data

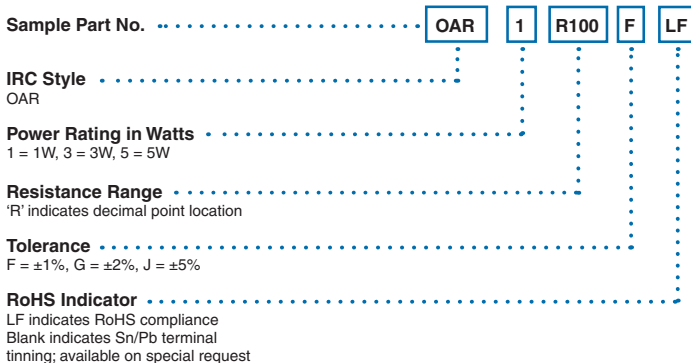

### General Note

TT electronics reserves the right to make changes in product specification without notice or liability. All information is subject to TT electronics' own data and is considered accurate at time of going to print.



www.bitechnologies.com www.irctt.com www.welwyn-tt.com